







Product Code

800mm x 1200mm 100-05-002

Material - High Density Polyethylene (HDPE)

Designed to British and European Standards - BS EN 1176

Fundamental Movement Skills

 Agility <input checked="" type="checkbox"/>	 Running <input checked="" type="checkbox"/>	 Jumping <input checked="" type="checkbox"/>	 Throwing <input checked="" type="checkbox"/>
 Balance <input type="checkbox"/>	 Catching <input checked="" type="checkbox"/>	 Kicking <input type="checkbox"/>	

Please contact us if you require further information about Fundamental Movement Skills

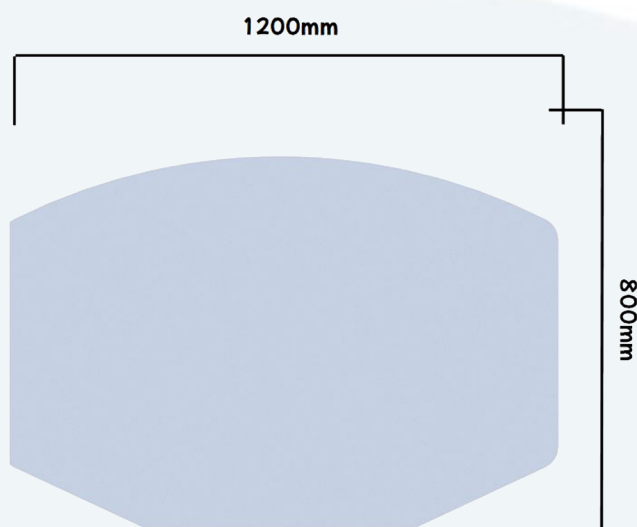

Age Range = N/A

Approx. Weight

100-05-002 = 17kg

Note - Installation method is for guideline purposes only.